

POSITRONIC INDUSTRIES BELIEVES THE DATA ON THIS DRAWING TO BE RELIABLE. SINCE THE TECHNICAL INFORMATION IS GIVEN FREE OF CHARGE, THE USER EMPLOYS SUCH INFORMATION AT HIS OWN DISCRETION AND RISK. POSITRONIC INDUSTRIES ASSUMES NO RESPONSIBILITY FOR RESULTS OBTAINED OR DAMAGES INCURRED FROM USE OF SUCH INFORMATION IN WHOLE OR IN PART.

DATE	REV	REVISION RECORD	APP	DR	CK
12-5-03	NC	ECO 21779	RCW	ME	TK
1-8-07	A	ECO 27282		YK	

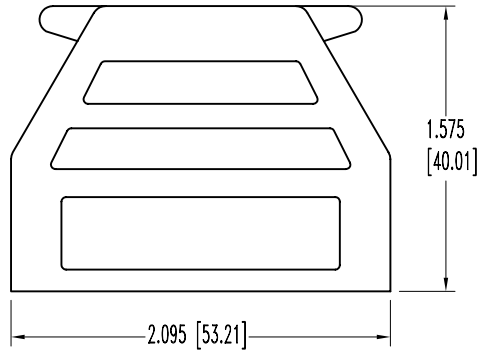

HOOD(1)

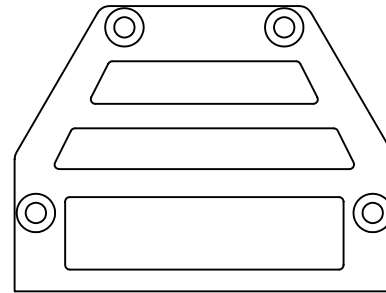

COVER(1)

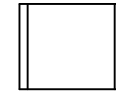
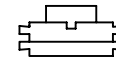

PLUG(2)

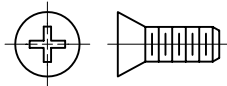

COVER SCREW(4)

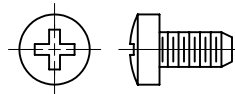

INTERNAL GROUNDING SCREW(1)

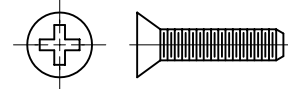

CABLE CLAMP SCREW(2)

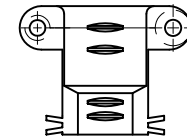

CABLE CLAMP (1 SET)



MOUNTING SCREW(2)

NOTES:

- HOOD CONSISTS OF: (1) HOOD, (1) COVER, (2) PLUGS, (4) COVER SCREWS, (1) INTERNAL SCREW, (2) MOUNTING SCREWS, 1 SET CABLE CLAMPS AND (2) CABLE CLAMP SCREWS.
- ALL DIMENSIONS ARE SHOWN FOR REFERENCE ONLY.
-
- DIMENSIONS ARE IN INCHES [MILLIMETERS].

 POSITRONIC INDUSTRIES INC. www.connectpositronic.com		SCALE: N.T.S. DRAWN BY: M. ENEA APPROVED BY: RCW	
DECIMAL TOL. ± N/A ANGULAR TOL. ± N/A		D SERIES TITLE: D25000G00 DATE: 12-5-03 DRAWING NUMBER: SK5247 REV.: A	