

# BABY KING COBRA

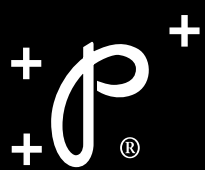

## Miniature, Economical & Rugged Circular Connector Systems

### Connector Versions

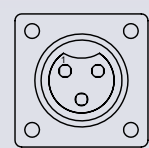

**BKC320:**  
Three (3) Size 20  
Contacts

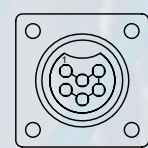

**BKC620:**  
Six (6) Size 20  
Contacts

### Technical Characteristics

#### Materials and Finishes

**Insulator:** Glass-filled nylon, UL 94V-0.  
**Contacts:** Precision machined copper alloy with gold over nickel plate.  
**'O' Ring:** Silicon, UL 94V-0

#### Electrical Characteristics

**Contact Current Ratings**  
Size 20 Contacts: 7.5 amperes nominal.  
**Initial Contact Resistance per IEC 512-2, Test 2b.**  
Size 20 Contacts: 0.005 ohms, maximum.  
**Insulator Resistance per IEC 512-2, Test 3a.**  
Insulator: 5 G ohms, minimum.

#### Proof Voltage

Size 20 Contacts: 1000 V r.m.s.

#### Working Voltage

Size 20 Contacts: 250 V r.m.s.

#### Climatic Characteristics

Working temperature: -55°C to +125°C

#### Dust and Water Ingress:

IP65 with overmolded Assemblies (Consult Factory for details)

#### Mechanical Characteristics

**Polarization:** Provided by insulator.

#### Fixed Contacts:

Size 20 female contacts feature "Open Entry" 500 cycles design.

#### Contact Retention in Insulator:

Size 20 Contacts: 27 N [6 lbs.] minimum.

#### Locking System:

Threaded or Twist Locking Shroud

#### UL :

File E220614



**POSITRONIC**  
GLOBAL *Connector* SOLUTIONS

[www.connectpositronic.com](http://www.connectpositronic.com)



# Outline Dimensions



## THREADED LOCKING SYSTEM

### Male Connector

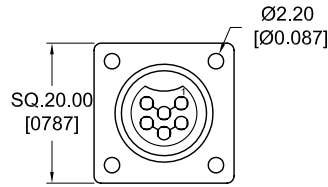
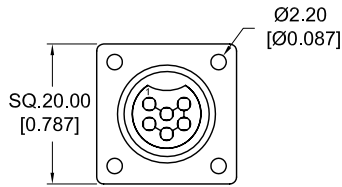
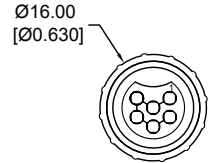
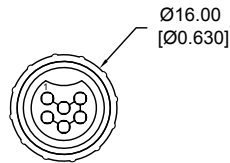
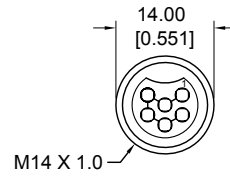
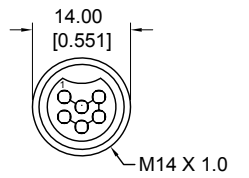
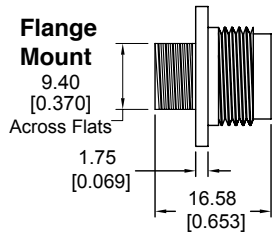
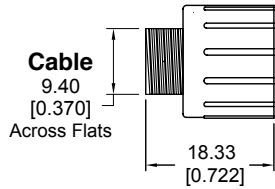
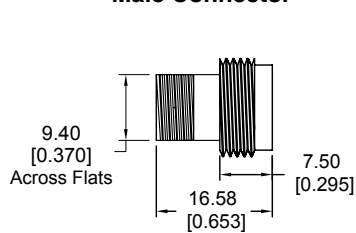

### Female Connector

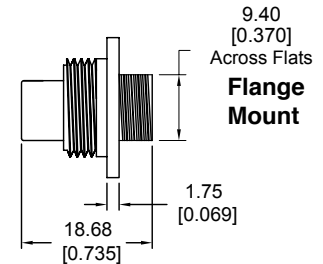
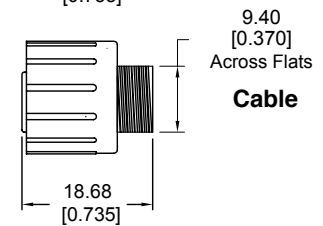
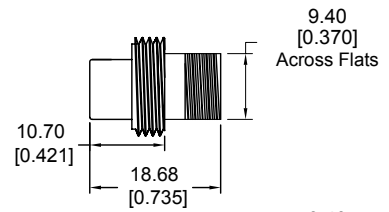

## TWIST LOCKING SYSTEM

### Male Connector

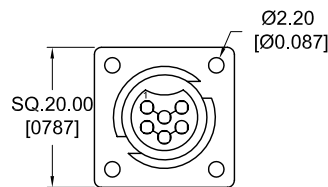
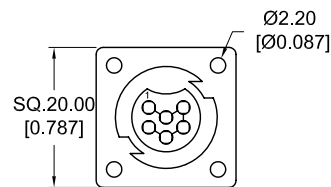
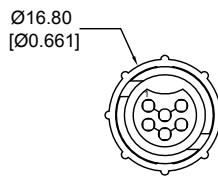
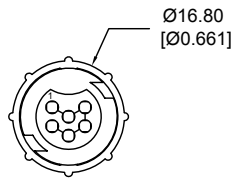
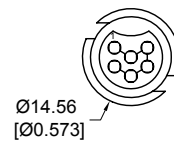
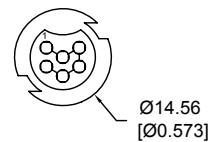
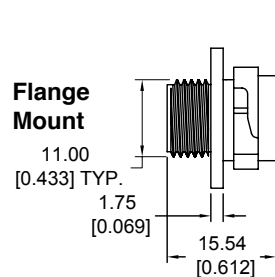
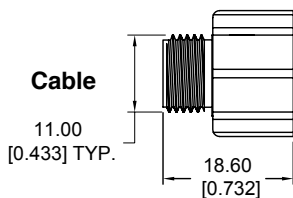
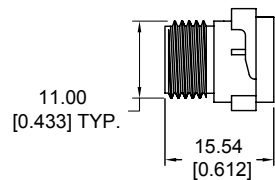

### Female Connector

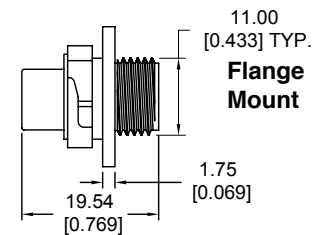
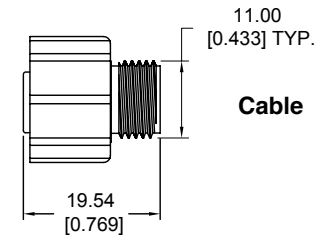
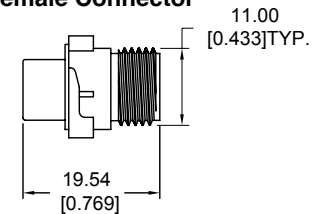

Above Dimensions are same for both BKC320 and BKC620 versions.





## Solder Cup Contacts

### Male Connector

Typical Part Number:  
BKC620M2T10

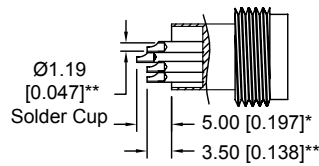

Typical Part Number:  
BKC620M2TW10

Specify code M2TW  
in Step 2

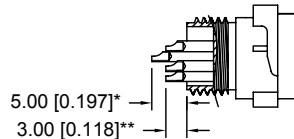

### Female Connector

Typical Part Number:  
BKC620F2T20

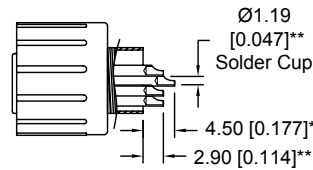

Typical Part Number:  
BKC620F2TW30

Specify code F2TW in  
Step 2

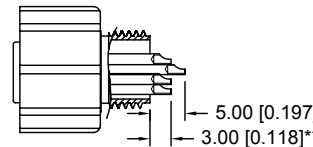

\* applicable for BKC620 only.  
\*\* applicable for BKC620 and BKC320.

## ACCESSORIES

### Connector with Hood Male or Female

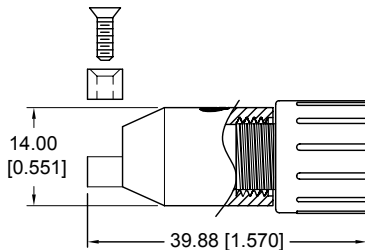

**Materials:**  
Hood & Clamp: Nylon, UL 94V-0.  
Screws: Steel with zinc plate.

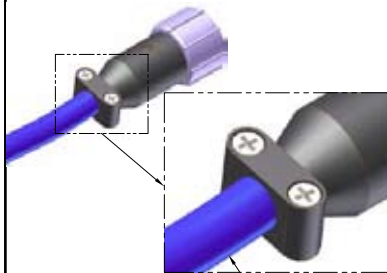

Note: Hood design can accommodate jacketed cable Ø between 4.50mm [0.177] to 6.00mm [0.236]

### Panel Mounting Option

#### Rear Panel Mount

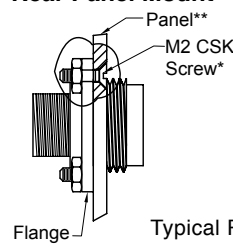

Typical Part Number:  
BKC320M2T1FT  
BKC620M2T1PF

#### Front Panel Mount

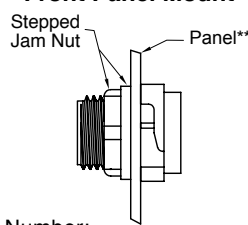

Typical Part Number:  
BKC320M2TW1P  
BKC620M2TW1P

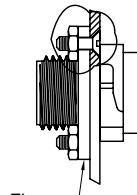

Typical Part Number:  
BKC320M2TW1PF  
BKC620M2TW1PF

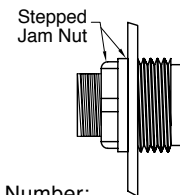

Typical Part Number:  
BKC320M2T1P  
BKC620M2T1P

**Materials:**  
Screws and Nuts: Steel with zinc plate.  
\*Screw and nut shown for reference only.  
\*\*Panel thickness 1.50 [0.059] max only.

### Panel Cutout

#### Front Mount (Jam Nut)

##### Twist Lock Cutout

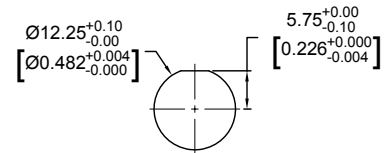

##### Threaded Lock Cutout

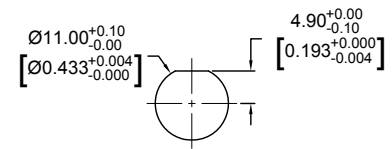

#### Rear Mount Cutout for Threaded Lock or Twist Lock Connector with Flange

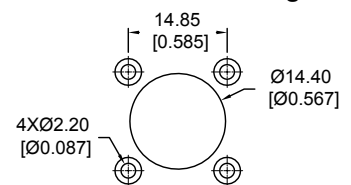

### Dust Cover

#### Panel Mount

#### Cable

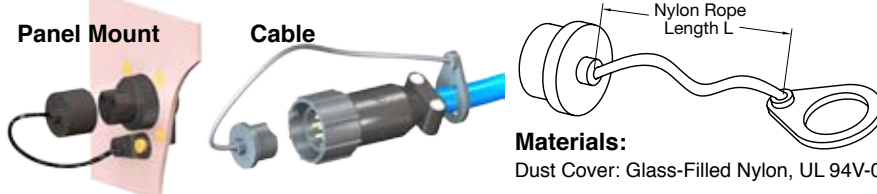

**Materials:**  
Dust Cover: Glass-Filled Nylon, UL 94V-0.

Ordering Part Numbers:  
(Female Dust Cover Part Number)  
5132-19-1 L=100[3.937]  
5132-19-2 L=35[1.378]

For Male Dust Cover, please consult factory.  
The above part numbers to be ordered separately.

Unless otherwise specified, dimensional tolerances are:

- 1) Male contact mating diameters : ±0.03 [0.001]
- 2) Contact termination diameters : ±0.08 [0.003]
- 3) All other diameters : ±0.13 [0.005]
- 4) All other dimensions : ±0.38 [0.015]

Dimensions are in millimeters [inches].  
All dimensions are subject to change.

**For Overmolded  
BKC Series Cable Assemblies.  
Please Contact Sales.**

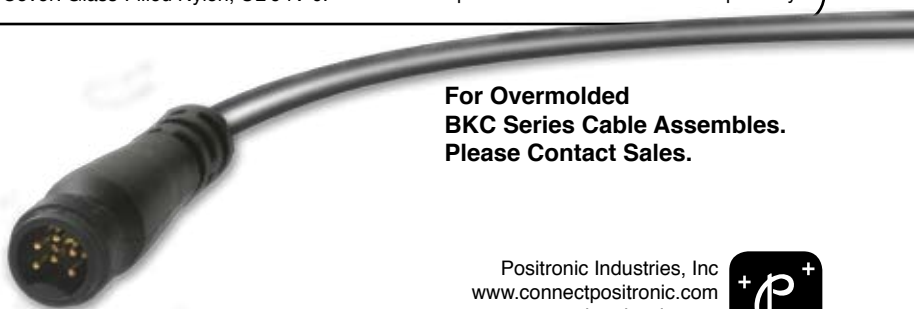



**Typical Connector Assembly  
Threaded Locking System**

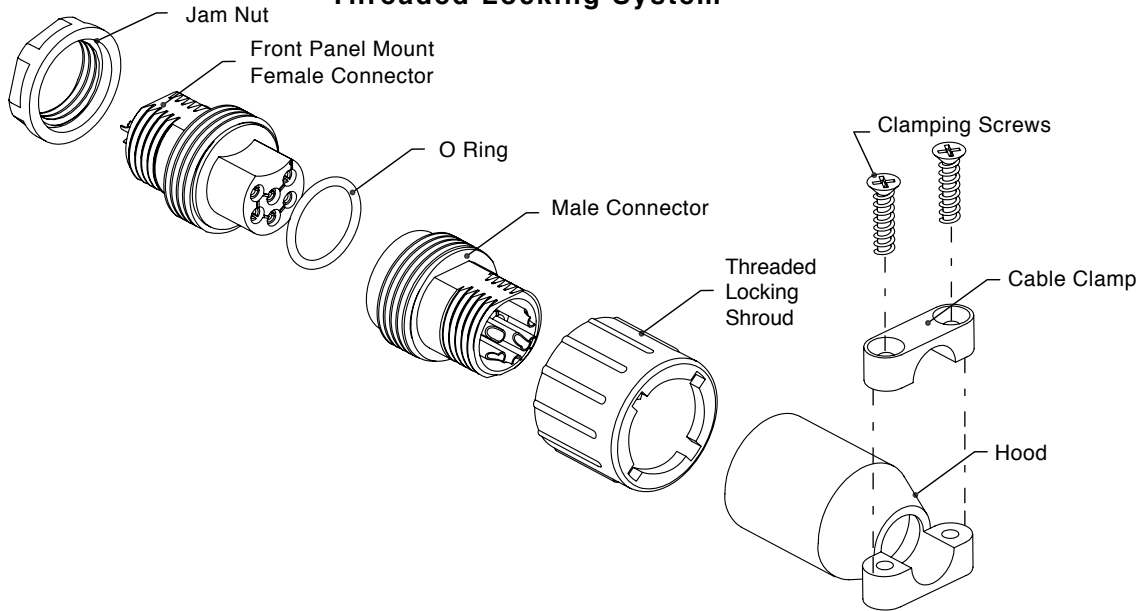

**Connector Ordering Information**

Specify complete connector by following step 1 through step 5.

Step	1	2	3	4	5
Example	BKC620	F2T1	PF	/AA	- XXX

<p><b>STEP 1: CONNECTOR VERSION</b> Baby King Cobra Series - BKC620 : Six (6) size 20 contacts. BKC320 : Three (3) size 20 contacts.</p>		<p><b>STEP 6 - SPECIAL OPTIONS</b> Consult factory for special options.</p>
<p><b>STEP 2: CONNECTOR GENDER AND TYPE OF CONTACTS</b></p> <p>M2T1 : Threaded Male, solder cup, fixed contacts. (Supplied Without Threaded Locking Shroud)</p> <p>F2T1 : Threaded Female, solder cup, fixed contacts. (Supplied Without Threaded Locking Shroud)</p> <p>M2T2 : Threaded Male, solder cup, fixed contacts. (Supplied With Threaded Locking Shroud)</p> <p>F2T2 : Threaded Female, solder cup, fixed contacts. (Supplied With Threaded Locking Shroud) (M2T1 mates only with F2T2 or F2T1.) (F2T1 mates only with M2T2 or M2T1.)</p> <p>M2TW1 : Twist Male, solder cup, fixed contacts. (Supplied without Twist Locking Shroud)</p> <p>F2TW1 : Twist Female, solder cup, fixed contacts (Supplied without Twist Locking Shroud)</p> <p>M2TW3 : Twist Male, solder cup, fixed contacts. (Supplied with Twist Locking Shroud)</p> <p>F2TW3 : Twist Female, solder cup, fixed contacts. (Supplied with Twist Locking Shroud) (M2TW1 mates only with F2TW3 or F2TW1.) (F2TW1 mates only with M2TW3 or M2TW1.)</p>	<p><b>STEP 4: ENVIRONMENTAL COMPLIANCE OPTION</b> /AA : Compliance per EU Directive 2002/95/EC (RoHS) Example: BKC620M2T2P/AA. Note : If RoHS legislation is not required, this step will not be used. Example: BKC620M2T2P.</p>	<p><b>STEP 3: MOUNTING STYLES AND HOOD</b></p> <p>0 : None.</p> <p>P : Panel mount with jam nut and without flange. (Available in Front Mount version only)</p> <p>PF : Panel mount with Flange and without jam nut. (Available in Rear Mount version only)</p> <p>J : Hood.</p>
<p>Above views applicable for both BKC620 and BKC320 versions.</p>		

Positronic believes the data contained herein to be reliable. Since the technical information is given free of charge, the user employs such information at his own discretion and risk. Positronic assumes no responsibility for results obtained or damages incurred from use of such information in whole or in part.

**POSITRONIC INDUSTRIES, INC.**  
423 N Campbell Ave, PO Box 8247  
Springfield, MO 65801, USA  
Telephone (417) 866-2322  
Fax (417) 866-4115  
Toll Free (800) 641-4054  
info@connectpositronic.com

**POSITRONIC INDUSTRIES, S.A.S.**  
Zone Industrielle d'Engachies  
46 Route d'Engachies  
France 32020 Auch Cedex 9  
Telephone 33 (0) 5 6263 4491  
Fax 33 (0) 5 6263 5117  
contact@connectpositronic.com

**POSITRONIC ASIA PTE LTD.**  
Blk 3014A  
Ubi Road 1 #07-01  
Singapore 408703  
Telephone 65 6842 1419  
Fax 65 6842 1421  
singapore@connectpositronic.com