

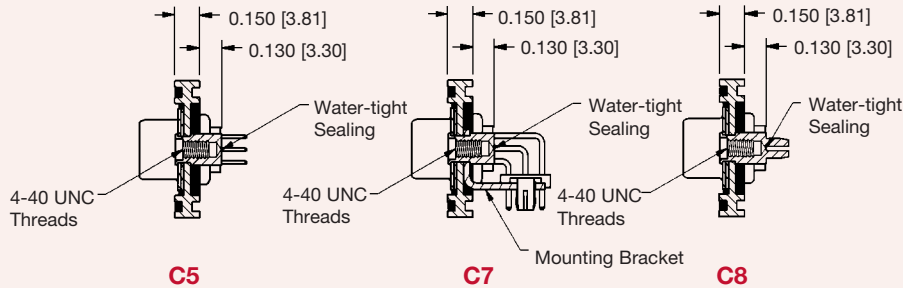

**CUL-DE-SAC STYLE MOUNTING ACCESSORIES**

FOR USE WITH WD AND WDD SERIES  
CODE C5, C7 AND C8 (STEP 5)

**INSIDE WALL**



**C5**  
STEEL, ZINC PLATE  
WITH CHROMATE SEAL  
OR STAINLESS STEEL,  
PASSIVATED

**C7**  
STEEL, ZINC PLATE  
WITH CHROMATE SEAL,  
OR STAINLESS STEEL,  
PASSIVATED

**C8**  
PHOSPHOR BRONZE,  
TIN PLATE

**OUTSIDE WALL  
ENCLOSURE MOUNT**  
*Not available in Unibody design.*  
See Unique Feature  
section, page 46.

ACCESSORIES

**ENCLOSURE WALL MOUNT SEALING PLATE**

FOR USE WITH WD AND WDD SERIES  
CODE A (STEP 6)

**INSIDE WALL ENCLOSURE MOUNT**

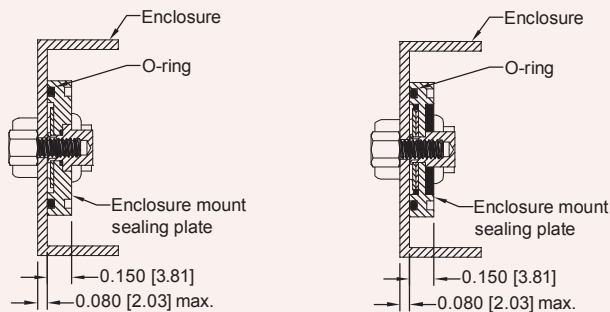

**UNIBODY DESIGN**

**LEGACY DESIGN**

**OUTSIDE WALL  
ENCLOSURE MOUNT**  
*Not available in Unibody design.*  
See Unique Feature  
section, page 46.

**Sealing Plate Material:**  
Glass filled thermoplastic

**Note:** Sealing plate is mounted to enclosure wall with jackscrews torqued to a value of 1.75 in-lb [0.20 Nm] minimum, 2.25 in-lb [0.25 Nm] maximum.

CONNECTOR VARIANT		A	B
WD	WDD		
9	15	0.67 [17.02]	0.34 [8.64]
15	26	1.00 [25.40]	0.34 [8.64]
25	44	1.53 [38.86]	0.34 [8.64]
37	62	2.18 [55.37]	0.34 [8.64]
50	78	2.08 [52.83]	0.45 [11.43]

**INTERFACIAL SEAL**  
FOR USE WITH WD, AND WDD SERIES\*  
FURNISHED ON ALL MALE CONNECTORS

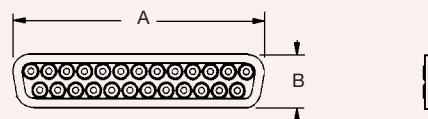

**Material:** Thermoplastic Elastomer (TPE), Santoprene™ or equivalent.

**\*NOTE:**  
For information on the interfacial seal supplied with EVD Series, see page 38.



**COMPOSITE HOODS**  
FOR USE WITH WD, WDD OR EVD SERIES  
CODE Z OR Z4 (STEP 6)

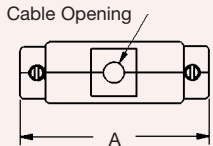

**CODE Z:** Composite hood with rotating male jackscrews.

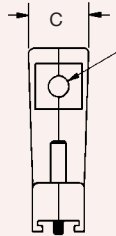
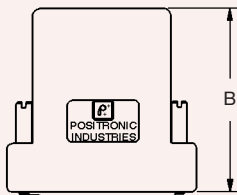

Cable Opening  
(Side cable opening not available for size 50 hood)

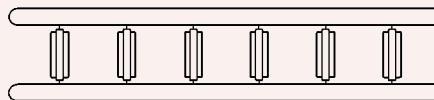

Insert Tree Assembly

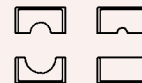

Typical Inserts

Various inserts are provided to accommodate different cable sizes

Typical part number:  
**D25000Z00**

Rotating Male Jackscrews  
4-40 UNC Threads, Steel, Zinc plated or Stainless Steel, passivated

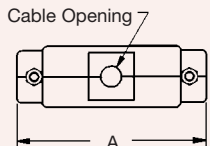

**CODE Z4:** Composite hood with fixed female jackscrews.

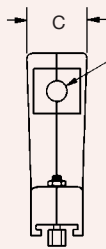
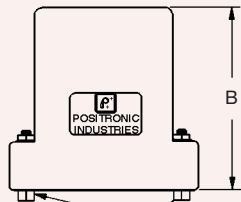

Cable Opening  
(Side cable opening not available for size 50 hood)

Typical part number:  
**D25000Z400**

Fixed Female Jackscrews  
4-40 UNC Threads, Steel, Zinc plated or Stainless Steel, passivated

PART NUMBER	A	B	C	Cable Opening	
				MIN.	MAXIMUM
D9000Z00 D9000Z400	1.387 [35.23]	1.935 [49.15]	0.735 [18.67]	0.100 [2.54]	0.400 x 0.570 [10.16] x [14.48]
D15000Z00 D15000Z400	1.715 [43.56]	1.935 [49.15]	0.735 [18.67]	0.100 [2.54]	0.400 x 0.570 [10.16] x [14.48]
D25000Z00 D25000Z400	2.254 [57.25]	2.200 [55.88]	0.735 [18.67]	0.100 [2.54]	0.550 x 0.570 [13.97] x [14.48]
D37000Z00 D37000Z400	2.903 [73.74]	2.200 [55.88]	0.735 [18.67]	0.100 [2.54]	0.550 x 0.570 [13.97] x [14.48]
D50000Z00 D50000Z400	2.809 [71.35]	2.700 [68.58]	0.900 [22.86]	0.100 [2.54]	Ø 0.630 [16.00]

**Material:** Composite, conductive volume resistivity [1.0 OHM-cm max]. Alternate material: Glass filled nylon, UL 94V-0.

**Attenuation:** 40+ decibels

**MOLDED CABLE ASSEMBLY**  
EMI ENVIRONMENT INGRESS PROTECTION CODE IP67  
AVAILABLE WITH WD, WDD AND EVD SERIES

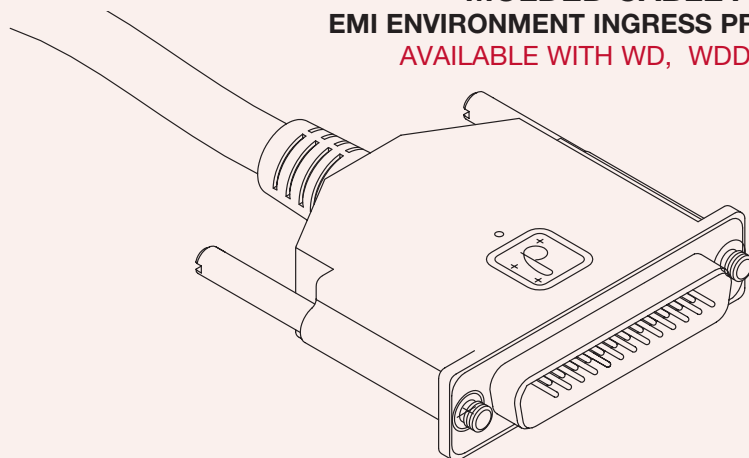

**CONTACT TECHNICAL SALES  
FOR MORE INFORMATION**



**ENCLOSURE WALL CUTOUT FOR CONNECTORS**  
WD SERIES AND WDD SERIES

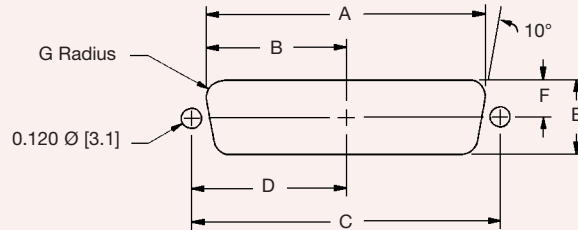

SHELL SIZE	WD	WDD	MOUNTING	A ±0.005	B ±0.005	C ±0.005	D ±0.005	E ±0.005	F ±0.005	G ±0.002
1	9	15	Inside Wall	0.806 [20.47]	0.403 [10.24]	0.984 [24.99]	0.492 [12.50]	0.449 [11.40]	0.225 [5.72]	0.132 [3.35]
			Outside Wall	0.874 [22.20]	0.437 [11.10]	0.984 [24.99]	0.492 [12.50]	0.513 [13.03]	0.257 [6.53]	0.083 [2.11]
2	15	26	Inside Wall	1.134 [28.80]	0.567 [14.40]	1.312 [33.32]	0.656 [16.66]	0.449 [11.40]	0.225 [5.72]	0.132 [3.35]
			Outside Wall	1.202 [30.53]	0.601 [15.27]	1.312 [33.32]	0.656 [16.66]	0.513 [13.03]	0.257 [6.53]	0.083 [2.11]
3	25	44	Inside Wall	1.674 [42.52]	0.837 [21.26]	1.852 [47.04]	0.926 [23.52]	0.449 [11.40]	0.225 [5.72]	0.132 [3.35]
			Outside Wall	1.743 [44.27]	0.872 [22.15]	1.852 [47.04]	0.926 [23.52]	0.513 [13.03]	0.257 [6.53]	0.083 [2.11]
4	37	62	Inside Wall	2.326 [59.08]	1.163 [29.54]	2.500 [63.50]	1.250 [31.75]	0.449 [11.40]	0.225 [5.72]	0.132 [3.35]
			Outside Wall	2.391 [60.73]	1.196 [30.38]	2.500 [63.50]	1.250 [31.75]	0.513 [13.03]	0.257 [6.53]	0.083 [2.11]
5	50	78	Inside Wall	2.218 [56.34]	1.109 [28.17]	2.406 [61.11]	1.203 [30.57]	0.555 [14.10]	0.278 [7.06]	0.132 [3.35]
			Outside Wall	2.297 [58.34]	1.149 [29.18]	2.406 [61.11]	1.203 [30.57]	0.623 [15.82]	0.312 [7.92]	0.083 [2.11]

ACCESSORIES

**PROTECTIVE COVER**

SUPPLIED AS STANDARD WITH ALL CONNECTORS  
WD, WDD AND EVD SERIES

**COVER WITHOUT EARS**

(FOR CONNECTORS WITHOUT FIXED JACKSCREWS)



**Material:** Conductive polyethylene  
**Color:** Black  
**Optional :**  
**Material:** Static dissipative ethylene vinyl acetate  
**Optional:** Pink

**COVER WITH EARS**

(FOR CONNECTORS WITH FIXED JACKSCREWS)

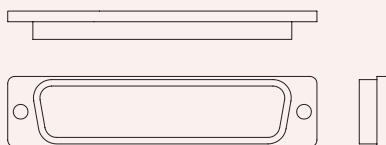

**Material:** Conductive polyester  
**Color:** Black

WD EVD	WDD	CONDUCTIVE REPLACEMENT PART NUMBER WITHOUT EARS	STATIC DISSIPATIVE REPLACEMENT PART NUMBER WITHOUT EARS	REPLACEMENT PART NUMBER WITH EARS
9M	15M	4931-9-0-0	4931-9-1-0	4931-9-100-0
9F	15F	4932-9-0-0	4932-9-1-0	4932-9-100-0
15M	26M	4931-15-0-0	4931-15-1-0	4931-15-100-0
15F	26F	4932-15-0-0	4932-15-1-0	4932-15-100-0
25M	44M	4931-25-0-0	4931-25-1-0	4931-25-100-0
25F	44F	4932-25-0-0	4932-25-1-0	4932-25-100-0
37M	62M	4931-37-0-0	4931-37-1-0	4931-37-100-0
37F	62F	4932-37-0-0	4932-37-1-0	4932-37-100-0
50M	78M	4931-50-0-0	4931-50-1-0	4931-50-100-0
50F	78F	4932-50-0-0	4932-50-1-0	4932-50-100-0