

SK6659

POSITRONIC INDUSTRIES BELIEVES THE DATA ON THIS DRAWING TO BE RELIABLE. SINCE THE TECHNICAL INFORMATION IS GIVEN FREE OF CHARGE, THE USER EMPLOYS SUCH INFORMATION AT HIS OWN DISCRETION AND RISK. POSITRONIC INDUSTRIES ASSUMES NO RESPONSIBILITY FOR RESULTS OBTAINED OR DAMAGES INCURRED FROM USE OF SUCH INFORMATION IN WHOLE OR IN PART.

DATE	REV	REVISION RECORD	APP	DR	CK
10-19-05	NC	ECO 24887		ME	

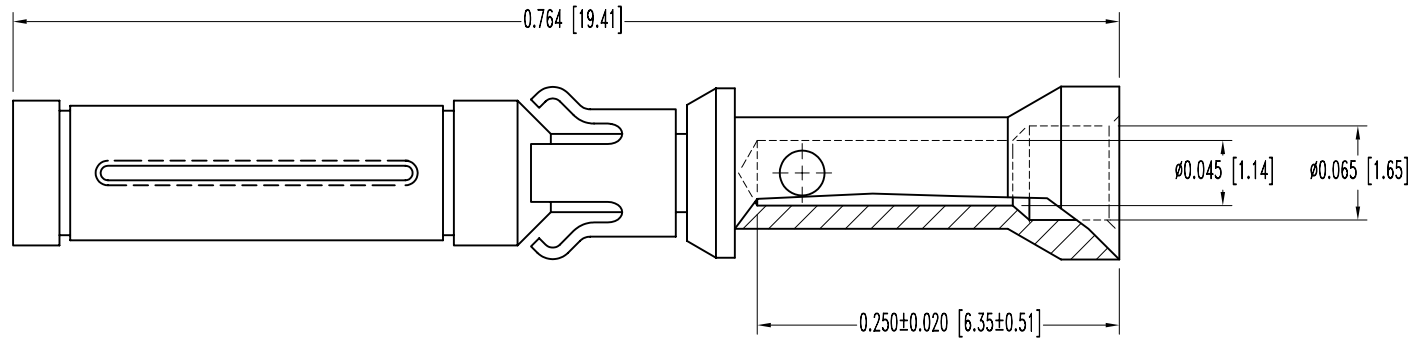

NOTES:

- MATERIALS AND FINISHES:
 CONTACT: COPPER ALLOY, GOLD FLASH OVER NICKEL PLATE.
 SPRING CLIP: BERYLLIUM COPPER, GOLD FLASH OVER NICKEL PLATE.
 RETAINER: BERYLLIUM COPPER, GOLD FLASH OVER NICKEL PLATE.
- CONTACTS ARE ROHS COMPLIANT PER ROHS DIRECTIVE 2002/95/EC OF 27 JAN 2003.
- DIMENSIONS ARE IN INCHES [MILLIMETERS].

 POSITRONIC INDUSTRIES INC. www.connectpositronic.com		SCALE		DRAWN BY	
 GMCT SERIES		N.T.S.		M. ENEA	
DECIMAL TOL. ± 0.015 [0.38]		TITLE FC120N2/AA			
ANGULAR TOL. ± 5°		DATE 10-19-05		DRAWING NUMBER SK6659	
				REV. NC	